

# ***AMR-OP3xA***

## ***On-wall controller***

Operation manual

*Version 1.00*



AMiT, spol. s r.o. does not provide any warranty concerning the contents of this publication and reserves the right to change the documentation without obligation to inform any body or authority about it.

This document can be copied and redistributed under following conditions:

1. The whole text (all pages) must be copied without any changes.
2. All redistributed copies must retain the AMiT, spol. s r.o. copyright notice and any other notices contained in the documentation.
3. This document must not be distributed for purpose making of profit.

The names of products and companies used herein can be trademarks or registered trademarks of their respective owners.

AMiT is a registered trademark.

**Copyright (c) 2015, AMiT, spol. s r. o.  
Producer: AMiT, spol. s r. o.  
Naskové 3/1100, 150 00 Praha  
www.amit.cz**

**Technical support: support@amit.cz**

---

**Contents**

---

	History of revisions .....	4
	Related documentation.....	4
<b>1.</b>	<b>Introduction .....</b>	<b>5</b>
<b>2.</b>	<b>Technical parameters .....</b>	<b>6</b>
2.1.	Dimensions.....	7
2.2.	Recommended drawing symbol .....	8
<b>3.</b>	<b>Conformity assessment .....</b>	<b>9</b>
3.1.	Other tests.....	10
<b>4.</b>	<b>Power supply.....</b>	<b>11</b>
<b>5.</b>	<b>Controls and indication elements .....</b>	<b>12</b>
5.1.	User LEDs .....	12
5.2.	Controls .....	12
<b>6.</b>	<b>Communication lines.....</b>	<b>13</b>
6.1.	RS485 .....	13
6.2.	Connectors and terminals layout .....	14
<b>7.</b>	<b>Mounting .....</b>	<b>15</b>
7.1.	Installation rules.....	15
<b>8.</b>	<b>Programming.....</b>	<b>16</b>
8.1.	Setting of communication parameters .....	16
8.2.	Indication LED and service button .....	17
<b>9.</b>	<b>Factory settings .....</b>	<b>19</b>
<b>10.</b>	<b>Ordering information and completion .....</b>	<b>20</b>
10.1.	Completion .....	20
<b>11.</b>	<b>Maintenance .....</b>	<b>21</b>
<b>12.</b>	<b>Waste disposal.....</b>	<b>22</b>

## History of revisions

---

Document name: amr-op3xa\_g\_en\_100.pdf

Author: Zbyněk Říha

Revision	Date	Changes
100	03. 02. 2015	New document

## Related documentation

---

1. Help file for EsiDet part of **DetStudio** development environment  
file: Esidet\_cs.chm
2. Application Note AP0016 – Principles of using RS485 interface  
file: ap0016\_en\_xx.pdf

# 1. Introduction

---

AMR-OP3xA is a series of on wall controllers with different fitting. Possible variants are:

**AMR-OP30A**

**AMR-OP31A**

**AMR-OP33A**

**AMR-OP35A**

- Basic features**
- Measuring of room temperature
  - Up to 7 LEDs for mode indication \*)
  - Rotating controller (knob) \*)
  - Button \*)
  - Power supply 24 V DC
  - RS485 serial interface without galvanic separation
  - Mounting on the KU68 installation box

\*) fitting differs according to variant, see following table:

Controller type	Number of LEDs	Rotating controller	Button	Power supply	Com. line
AMR-OP30A	Not used.	Not used.	Not used.	24 V DC	RS485
AMR-OP31A	1 ×	1 ×	1 ×	24 V DC	RS485
AMR-OP33A	7 ×	Not used.	1 ×	24 V DC	RS485
AMR-OP35A	6 ×	1 ×	1 ×	24 V DC	RS485

## 2. Technical parameters

<b>CPU</b>	CPU	STM32F103CBT	
<b>Temperature measuring</b>	Sensor	DS7505S	
	Range	-10 °C to 50 °C	
	Temperature measuring precision	±0.5 °C	
	Settling time after switching	< 20 s	
<b>LED</b>	Quantity	0 / 1 / 6 / 7 (according to controller type)	
	Color	Green	
<b>Rotating controller</b>	Quantity	0 / 1 (according to controller type)	
<b>Button</b>	Quantity	0 / 1 (according to controller type)	
<b>RS485</b>	Number of lines	1	
	Overvoltage protection	Transil 600 W	
	Line termination	Jumpers inside the controller	
	Communication rate	9600 bps up to 57600 bps	
	Number of stations on RS485 network	Max. 256	
	Galvanic separation	No	
	Operation indication	LED on PCB inside the box	
	Connection point	WAGO 2091-1374	
	Wire cross section	0.2 mm <sup>2</sup> to 1.5 mm <sup>2</sup>	
<b>Power supply</b>	Nominal power supply voltage	24 V DC	
	Power supply voltage range	10 V to 30 V DC	
	Maximum power consumption	40 mA at 24 V DC	
	Connection point	WAGO 2091-1374	
	Wire cross section	0.2 mm <sup>2</sup> to 1.5 mm <sup>2</sup>	
<b>Mechanics</b>	Mechanical design	Plastic box, colour RAL 9010	
	Mounting	Mounting on the KU68 installation box	
	Ingress protection rate	IP20	
	Weight	– netto	0.04 kg ±5 %
		– brutto	0.08 kg ±5 %
	Dimensions (w × h × d)		(85 × 85 × 24) mm *)
		(85 × 85 × 30) mm **)	
*) applies for <b>AMR-OP30A</b> and <b>AMR-OP33A</b> units **) applies for <b>AMR-OP31A</b> and <b>AMR-OP35A</b> units			
<b>Temperatures</b>	Operating temperature range	-10 °C to 50 °C	
	Storage temperature range	-20 °C to 70 °C	
<b>Others</b>	Maximum ambient humidity	< 95 % non-condensing	
	Programming	DetStudio / EsiDet	

**2.1. Dimensions**

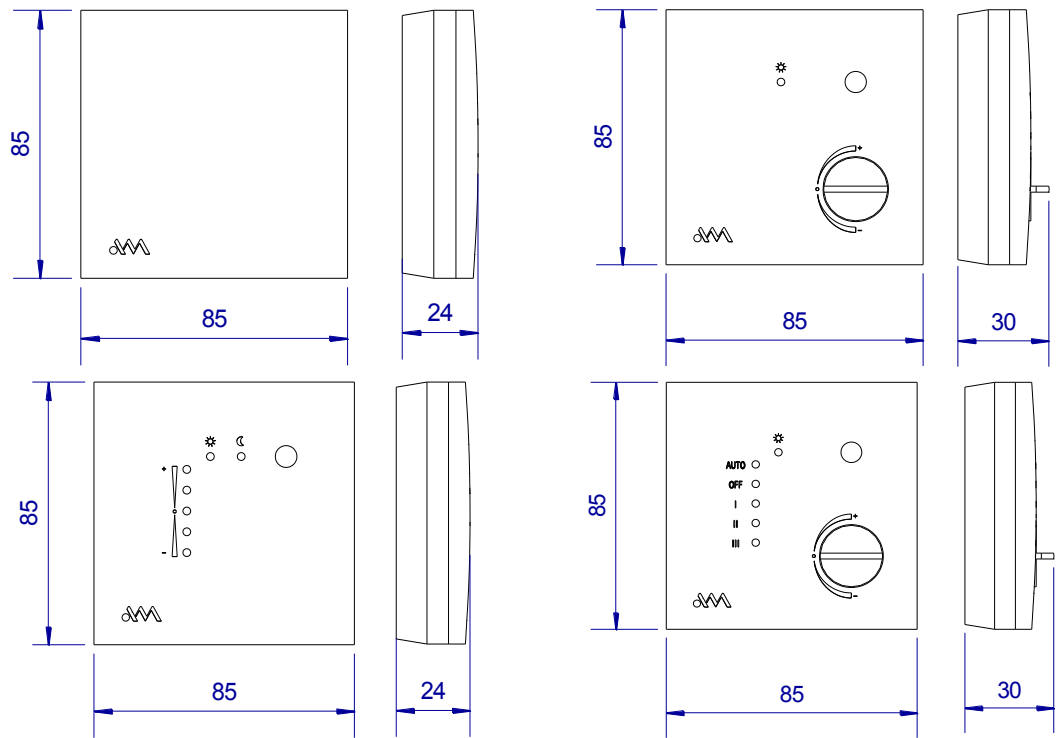

**Fig. 1 - AMR-OP30A, AMR-OP31A, AMR-OP33A, AMR-OP35A dimensions**

## 2.2. Recommended drawing symbol

Following drawing symbols are recommended for **AMR-OP3xA** series on-wall controllers. This drawing symbols are only partially visible in following examples.

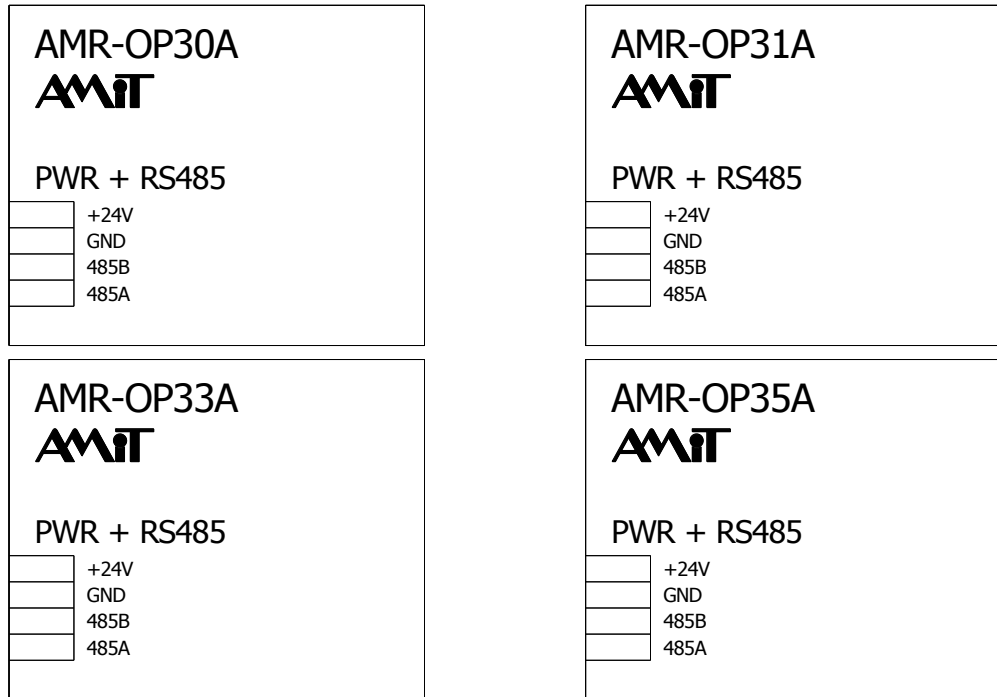

Fig. 2 - Recommended drawing symbol for **AMR-OP3xA** series on-wall controllers



### 3. Conformity assessment

The equipment meets the requirements of NV616/2006 Czech governmental decree. The conformity assessment has been carried out in accordance with harmonized standard EN 61326-1:2013

Tested in accordance with standard	Type of test	Classification
EN 55011:2009	Industrial, scientific and medical equipment – Radio-frequency disturbance characteristics – Limits and methods of measurement	Class B
EN 61000-4-2:2009	Electromagnetic compatibility (EMC) – Part 4-2: Testing and measurement techniques – Electrostatic discharge immunity test	Complies
EN 61000-4-3:2006	Electromagnetic compatibility (EMC) – Part 4-3: Radiated, radio-frequency, electromagnetic field immunity test, 80 MHz to 1000 MHz	10 V/m
EN 61000-4-3:2006	Electromagnetic compatibility (EMC) – Part 4-3: Radiated, radio-frequency, electromagnetic field immunity test, 1000 MHz to 2000 MHz	3 V/m
EN 61000-4-3:2006	Electromagnetic compatibility (EMC) – Part 4-3: Radiated, radio-frequency, electromagnetic field immunity test, 2000 MHz to 2700 MHz	1 V/m
EN 61000-4-4:2012	Electromagnetic compatibility (EMC) – Part 4-4: Testing and measurement techniques – Electrical fast transient/burst immunity test, power supply	±2 kV
EN 61000-4-5:2006	Electromagnetic compatibility (EMC) – Part 4-5: Testing and measurement techniques – Electrostatic discharge immunity test	±2 kV
EN 61000-4-6:2009	Electromagnetic compatibility (EMC) – Part 4-6: Testing and measurement techniques – Immunity to conducted disturbances, induced by radio-frequency fields	3 V

### 3.1. Other tests

---

Tested in accordance with standard	Type of test	Classification
EN 61000-4-29:2000	Electromagnetic compatibility (EMC) – Part 4-29: Testing and measurement techniques – Voltage dips, short interruptions and voltage variations immunity tests	Complies
EN 60068-2-1:2007	Environmental testing – Part 2-1: Test – Test A: Cold	Complies
EN 60068-2-2:2007	Environmental testing – Part 2-2: Test B: Dry heat	Complies

## 4. Power supply

AMR-OP3xA on-wall controllers can be powered by DC power sources, that meet the requirements, listed in chapter 2. Technical parameters.

**Wiring example**

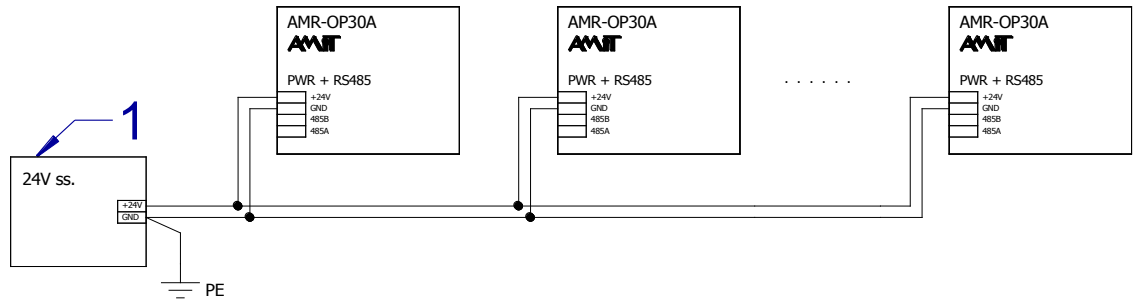

Fig. 3 - Power supply wiring example

*Legend*

Number	Meaning
1	Power supply 24 V DC

*Note* It is recommended to connect the GND terminal with PE terminal when installation is made.

## 5. Controls and indication elements

### 5.1. User LEDs

On-wall controller can be fitted with up to 7 LEDs. Difference between single on-wall controllers is in number and location of LEDs and in drawing symbol, see table in chapter 1. Introduction – basic features Their meaning is given by program equipment.

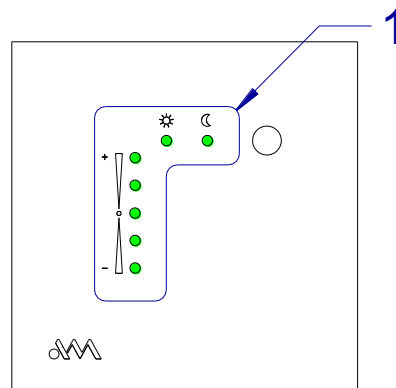

Fig. 4 - Indication LEDs on **AMR-OP33A** on-wall controller

<i>Legend</i>	
Number	Meaning
1	Indication LED

### 5.2. Controls

On-wall controller can be fitted with button and knob. Their meaning is given by program equipment. Difference between single on-wall controllers is in number and location of control elements, see table in chapter 1. Introduction – basic features

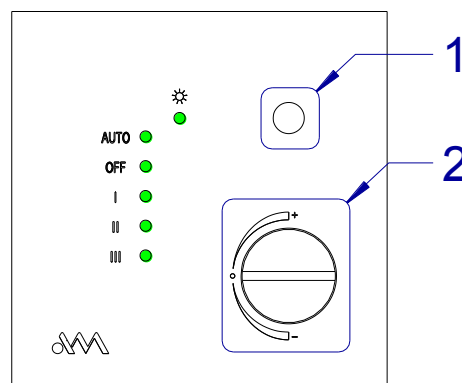

Fig. 5 - Control elements of **AMR-OP35A** on-wall controller

<i>Legend</i>	
Number	Meaning
1	Button for mode selection
2	Knob for setpoint correction

## 6. Communication lines

### 6.1. RS485

On-wall controller is connected with superior control system via RS485 communication bus. For proper working of RS485 it is necessary to abide the rules presented in Application Note AP0016 – Principles of using RS485 interface.

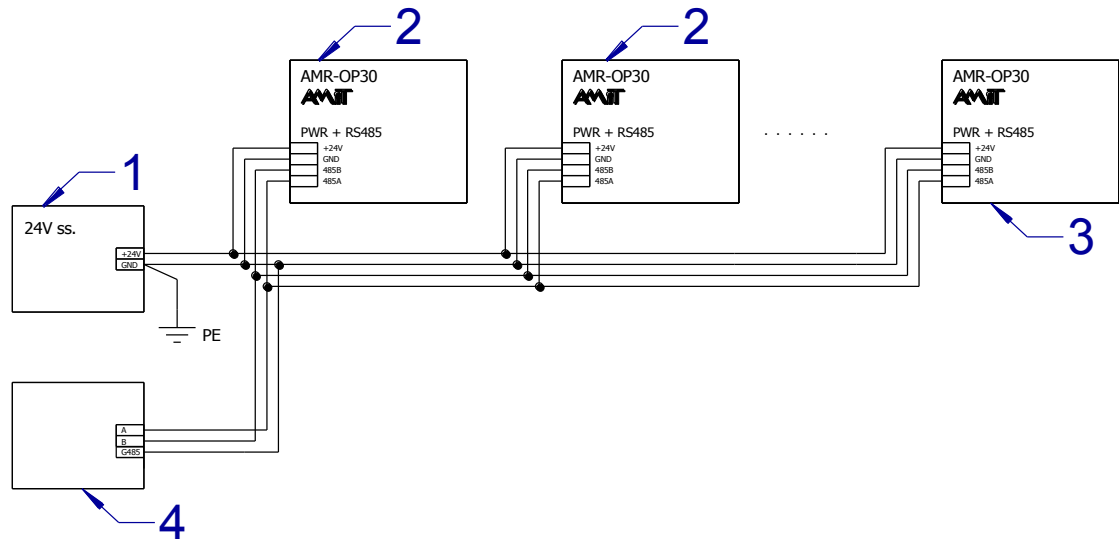

Fig. 6 - Connection of controller to CS

Legend

Number	Meaning
1	Power supply 24 V DC
2	Intermediate station
3	End station
4	Superior system as an end station

In case of using structured cabling, it is recommended to connect one pair of wires to the positive terminal, one pair of wires to the negative terminal and one pair of wires to connect RS485 line.

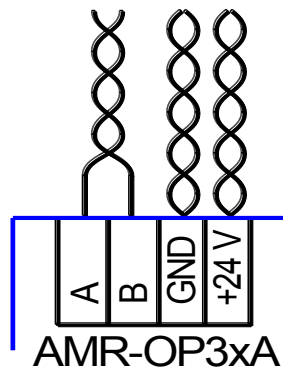

Fig. 7 - Connecting structured cabling to terminals of the controller

**Line termination** Termination and idle state definition are set by means of jumpers on the baseplate inside the controller. Both RS485 jumpers must be connected on the end station. Intermediate stations must have jumpers disconnected.

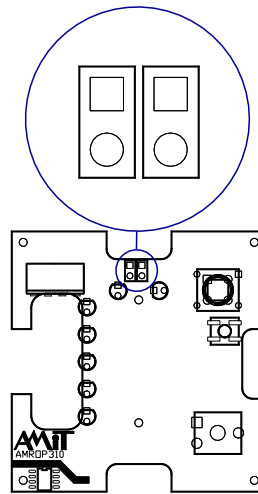

Fig. 8 - Location of jumpers for line termination

Jumpers	Meaning
Jumpers are not installed	Termination and idle state definition are not connected (intermediate station)
Jumpers are installed	Termination and idle state definition are connected (end station)

## 6.2. Connectors and terminals layout

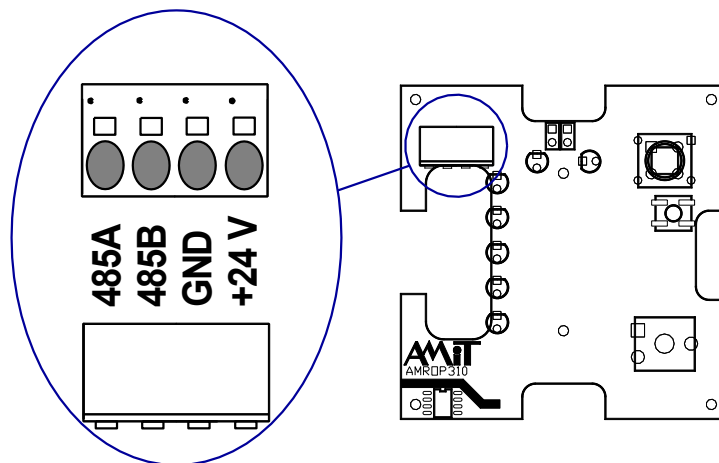

Fig. 9 - Connectors and terminals location

Terminal	Meaning
485A	RS485 line, signal A
485B	RS485 line, signal B
GND	Ground
+24V	Power supply voltage +24 V DC

## 7. Mounting

---

**AMR-OP3xA** on-wall controllers are intended to be mounted on KU68 installation box, in vertical position, in a place with good access of ambient air.

Device must be mounted so that the air can freely circulate through the controller air vents.

If the inlet cable are led through the “gooseneck” – it is necessary to prevent airflow from the “gooseneck”, to prevent influencing the measurement of the room temperature.

### 7.1. Installation rules

---

**EMC filter** Use an EMC filter on 230 V AC power supply input. Based on environment character and wiring layout this requirement can be revised.

Control system negative power supply terminal (24 V DC) connect to switchboard PE terminal.

**RS485 line** Use the shielded signal cables for wiring. Connect in one point the cable shielding with PE.

More on-wall controllers can be connected to single RS485 line segment without separating by repeater only when their power supplies have identical GND terminal (identical power supply).

*Note* All connections to PE terminal must be realized with impedance as low as possible. Technical parameters of on-wall controller are guaranteed only when these wiring rules are applied.

## 8. Programming

---

In **AMR-OP3xA** on-wall controller – loader with following communication parameters is implemented by manufacturer:

- address 1
- speed 38400 bps
- parity even

Communication parameters can be changed only from PC by using:

- DetStudio development environment
- AMRconfig service and programming utility

New application can be created by using:

- DetStudio / EsiDet development environment

Application software can be loaded into module by:

- DetStudio development environment
- AMRconfig service and programming utility
- AMRdownload multiprogramming utility

**SW download** Programs are available at [www.amit.cz](http://www.amit.cz), section Download.

### 8.1. Setting of communication parameters

---

Communication parameters can be changed only from PC by using:

- DetStudio development environment
- AMRconfig service and programming utility

On-wall controller **AMR-OP3xA** needs to be point-to-point attached via USB/RS485 converter (e.g. **SB485S** type from AMiT production).

To change the parameters, follow the Help for program equipment mentioned above.



## 8.2. Indication LED and service button

LED S0 serves for indication of module program status. Service button is located under the on-wall controller front panel. Button can be pushed by suitable unsharp tool.

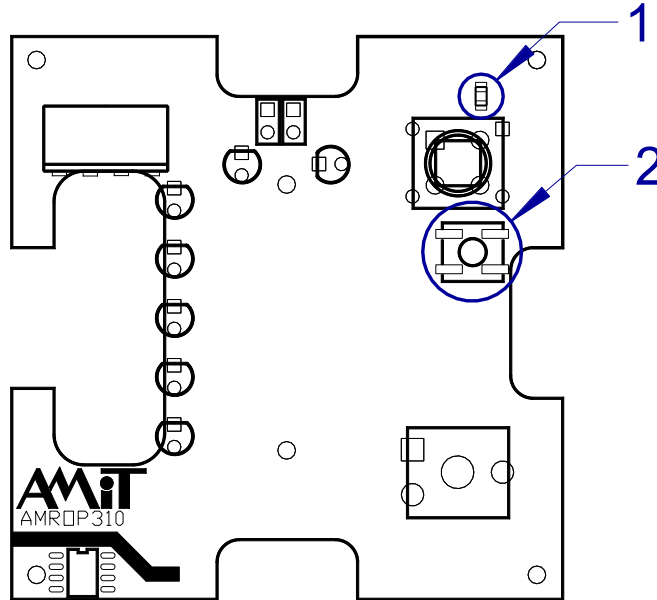

Fig. 10 - Location of indication LED's and service button

Legend	Number	Meaning
	1	Indication LED
	2	Service button

Indication LED	LED	Light	Meaning
	S0	Blinking 0.1 s During 1 s	Indication of going-through Reset
		Regular blinking with 0.2 s period	Loader is launched
		Regular blinking with 1 s period	Application run
		Irregular blinking with 0.5 s period	Running application is indicating error. Irregular blinking means, that a pause of to 2 s follows after a particular number of blinks. Number of blinks between to pauses indicates numeric error code: 1 – error reading from BackUp RAM 2 – error during reading from EEPROM 3 – suspiciously frequent writing to EEPROM 15 – unknown error

<i>Service button</i>	<b>Pressing length</b>	<b>Action</b>
	> 1 s – after turning-on	Starting the Loader. Communication parameters are kept. After each restart (unit power OFF / unit power ON) original application starts.
	> 3 s, but < 10 s – during application run	Starting the Loader. Communication parameters are kept. After each restart (unit power OFF / unit power ON) original application starts.
	> 10 s	Starting the Loader. Following communication parameters are set: address 1, 38400 bps, even parity. Switching to this state is indicated by LED S0 light. After the button is released – the Loader starts. After each restart (unit power OFF / unit power ON) original application with updated communication parameters starts.

## 9. Factory settings

---

**RS485 configuration** The RS485 line is fitted by jumpers, which activates the line termination and idle state definition.

**Communication parameters**

Item	Set value
Network type	MODBUS
Address	1
Rate	38400
Parity	Even

## 10. Ordering information and completion

<i>On-wall controller</i>	<b>AMR-OP30A</b>	Unit complete – see chapter 10.1 Completion
	<b>AMR-OP31A</b>	Unit complete – see chapter 10.1 Completion
	<b>AMR-OP33A</b>	Unit complete – see chapter 10.1 Completion
	<b>AMR-OP35A</b>	Unit complete – see chapter 10.1 Completion

### 10.1. Completion

<i>AMR-OP30A</i>	<b>Part</b>	<b>Quantity</b>
	On-wall controller	1

<i>AMR-OP31A</i>	<b>Part</b>	<b>Quantity</b>
	On-wall controller	1

<i>AMR-OP33A</i>	<b>Part</b>	<b>Quantity</b>
	On-wall controller	1

<i>AMR-OP35A</i>	<b>Part</b>	<b>Quantity</b>
	On-wall controller	1

## 11. Maintenance

---

Device requires no periodic control nor maintenance.

**Cleaning** Time after time with regard to way of device usage, it is necessary to remove dust from inside electronics. The equipment can be cleaned by dry soft brush or vacuum cleaner, only when turned-off and disassembled.

**Note** The maintenance mentioned above can be performed by manufacturer or authorized service only!

## 12. Waste disposal

---

**Electronics disposal** The disposal of electronic equipment is subject to the regulations on handling electrical waste. The equipment must not be disposed off in common public waste. It must be delivered to places specified for that purpose and recycled.